

ARGUS 180 flush-mounted sensor module

Operating instructions

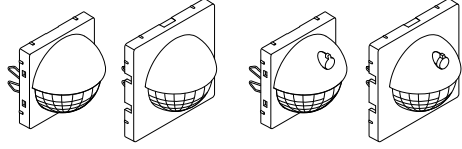

System M

ARGUS 180 flush-mounted sensor module

Art. no. MTN5710-03../04..

ARGUS 180 flush-mounted sensor module with switch

Art. no. MTN5711-03../04..

System Design

ARGUS 180 flush-mounted sensor module

Art. no. MTN5710-60..

ARGUS 180 flush-mounted sensor module with switch

Art. no. MTN5711-60..

Necessary accessories

- To be completed with:
- corresponding inserts (see function overview)
- Frame in corresponding design.

For your safety

⚠ DANGER
Risk of serious damage to property and personal injury, e.g. from fire or electric shock, due to incorrect electrical installation.

Safe electrical installation can only be ensured if the person in question can prove basic knowledge in the following areas:

- Connecting to installation networks
- Connecting several electrical devices
- Laying electric cables

These skills and experience are normally only possessed by skilled professionals who are trained in the field of electrical installation technology. If these minimum requirements are not met or are disregarded in any way, you will be solely liable for any damage to property or personal injury.

Getting to know the sensor module

The ARGUS 180 flush-mounted sensor module (referred to below as **sensor module**) is a movement detector for installation indoors. The sensor module detects moving heat sources (e.g. people) within an adjustable area of detection and triggers a staircase lighting function.

The maximum range of the sensor module is approx. 8 m to the left/right and approx. 12 m to the front at a 180° angle of detection. As long as movement is detected, the connected load remains switched on. The adjustable overshoot time only begins when no further movements are detected (trigger function).

The sensor module is equipped with a light sensor with an adjustable brightness threshold so that the lighting is only switched on when surroundings are below a specified brightness threshold (movement detector function).

If there is sufficient natural light, the switchable presence function allows the sensor module to switch off the lighting even when a person is present.

i The specified range and brightness threshold refer to average conditions at the recommended mounting height of approx. 1.10 m and should therefore be taken as guide values. The range can vary greatly when the temperature fluctuates.

For sensor modules with a switch, the function switch can be used to switch between "Automatic mode", permanently "ON" and permanently "OFF".

Function overview of the sensor module on receiving inserts

Complete the sensor module with the receiving inserts for switching or dimming in order to perform **local** light control and other functions.

Switching/dimming	
<ul style="list-style-type: none"> • Electronic switch insert • Relay switch insert • Universal dimmer insert • 1-10 V insert • Dali insert 	<p>Sensor module: brightness-dependent staircase lighting function</p>
<ul style="list-style-type: none"> • Electronic switch insert • Relay switch insert • Universal dimmer insert • 1-10 V insert • DALI insert 	<p>Sensor module with a switch: brightness-dependent staircase lighting function, permanently switching on/off</p>
<ul style="list-style-type: none"> • Electronic switch insert, 2-gang • Relay switch insert, 2-gang • Universal dimmer insert, 2-gang 	<p>Sensor module: Channel 1: brightness-dependent staircase lighting function, channel 2: brightness-independent staircase lighting function</p>
<ul style="list-style-type: none"> • Electronic switch insert, 2-gang • Relay switch insert, 2-gang • Universal dimmer insert, 2-gang 	<p>Sensor module with a switch: Channel 1: brightness-dependent staircase lighting function, permanently switching on/off Channel 2: brightness-independent staircase lighting function, permanently switching on/off</p>

Function overview of the sensor module on sending insert

Complete the sensor module with the sending central unit insert in order to perform **global** light control via the **PlusLink (PL)**.

Global light control:	
<ul style="list-style-type: none"> • Central unit insert 	<p>Sensor module / sensor module with switch: brightness-independent staircase lighting function</p>

Using the sensor module with alarm systems

- i** Movement/presence detectors are not suitable for use as components of an alarm system.
- i** Movement/presence detectors can trigger false alarms if the installation site is unsuitable.

Movement/presence detectors switch on as soon as they detect a moving heat source. This can be a person, but also animals or differences in temperature through windows. In order to avoid false alarms, the chosen installation site should be such that undesired heat sources cannot be detected (see section „Selecting the installation site“).

Connections, displays and operating elements

Front:

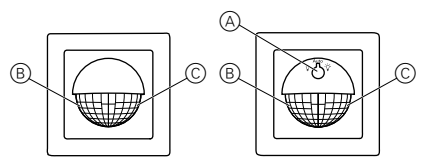

- (A)** Function switch:
 - : permanently "OFF"
 - Auto: "Automatic mode"
 - : permanently "ON"
- (B)** Green LED (during permanent ON/OFF switching via the function switch / 24-h staircase lighting circuit)
- (C)** Red LED (in test mode)

Rear:

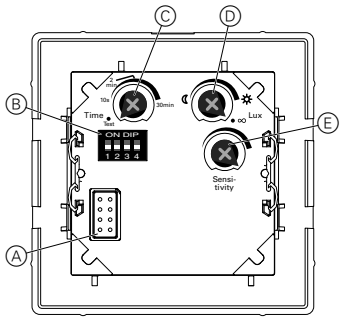

- (A)** Module interface
- (B)** DIP switches
 - 1: Presence function / movement detector function
 - 2: Double overshoot time for channel 2
 - 3: Prewarning for channel 1
 - 4: 24-h staircase lighting circuit
- (C)** Potentiometer for overshoot time
- (D)** Potentiometer for brightness threshold
- (E)** Potentiometer for sensitivity

Selecting the installation site

- Only mount the sensor module in positions that allow the desired area to be monitored optimally.

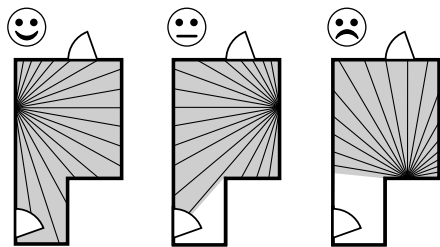

- Install the sensor module on the wall at a height of approx. 1.10 m above the floor. Any mounting height which deviates from this will affect the range.
- Install the sensor module laterally with respect to the direction of movement so that the beam paths are intersected as vertically as possible.
- Maximum area of detection of the sensor module: 180° angle of detection, approx. 12 m to the front, approx. 8 m to the left and right.

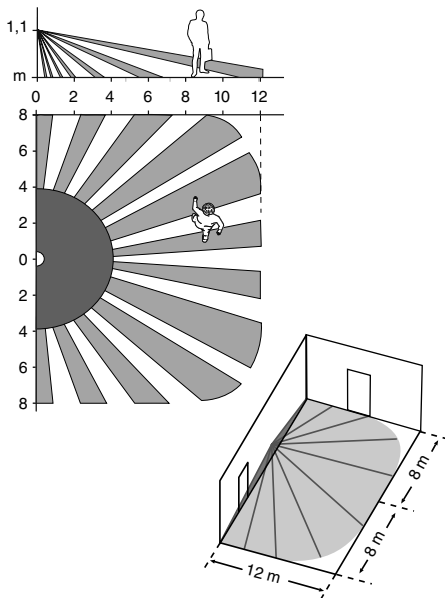

- In order to ensure continuous monitoring, e.g. of a long hall, the areas of detection of the individual sensor modules have to intersect.
- Movement/presence detectors detect objects that radiate heat. You should select an installation site that will not result in undesired heat sources being detected, such as:
 - Switched-on lamps in the area of detection
 - Open fires (such as in fireplaces)
 - Moving curtains, etc., that cause a different temperature in their surrounding environment due to strong sunlight.
 - Windows where the influence of alternating sunlight and clouds could cause rapid changes in temperature.
 - Larger heat sources (e.g. cars) that are detected through windows.
 - Rooms flooded with light where light is reflected on objects (e.g. the floor) which can be the cause of rapid changes in temperature.
 - Windowpanes heated up by sunlight
 - Dogs, cats, etc.
- To prevent faulty operation, the insert should be installed in a wind-resistant switch box. With switch boxes and pipe cabling systems, a draught of air at the back of the equipment can trigger the module.
- Avoid direct sunlight. This can destroy the sensor in extreme cases.

Mounting the sensor module

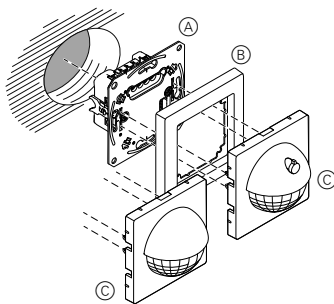

- (A) Insert (see function overview)
- (B) Frame
- (C) Sensor module with/without a switch

i When the mains voltage is activated, the sensor module switches channel 1 on for 30 s and then switches it off. Channel 2 remains switched off. During the following 2 s the sensor module does not react to any movement. After this initialisation period has elapsed, the sensor module is ready for operation.

Setting the sensor module

On the rear side of the sensor module, the potentiometer can be used to set the module's sensitivity, brightness threshold and overshoot time.

Additional possible settings using DIP switches:

		Pos. ON (upper)	Pos. OFF (lower)
DIP 1	Presence function	Active	Inactive
DIP 2	Double overshoot time for channel 2	Active	Inactive
DIP 3	Pre-warning for channel 1	Active	Inactive
DIP 4	24-h staircase lighting circuit via PlusLink	24 h "ON"	24 h "ON" or "OFF"

Setting the sensitivity

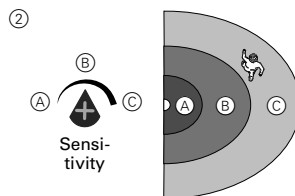

- Activate the test mode and set the brightness threshold to "infinite". The red LED lights up when movement is detected.
- Infinitely set the sensitivity.
- Walk around the area of detection and check whether the sensor module is switching as desired. Adjust the sensitivity if required.

Setting the brightness threshold

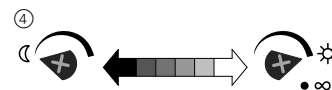

- Infinitely set the desired brightness threshold. The sensor module switches below the set brightness threshold.

- ☾ Detects movement in the dark (approx. 10 lux)
- ☀ Detects movement during daylight (approx. 1000 lux)
- ∞ Detects movement independently of brightness

- Check that the module switches at the desired/set brightness. Adjust the brightness threshold if required.

i In combination with a 2-gang insert, the brightness threshold only applies to channel 1. Channel 2 always switches independently of brightness.

Setting the staircase lighting function

You can set the type of staircase lighting function (with/without pre-warning) and the overshoot time.

When setting the overshoot time, you specify how long the connected load remains switched on (continuously from 10 s to 30 min.)

The pre-warning indicates the end of the overshoot time. The loads are switched off briefly and then back on again (in combination with switch inserts), or are dimmed down slowly (in combination with dimmable inserts). The loads are switched off after the pre-warning time has elapsed (30 s, not adjustable).

- Select the type of staircase lighting function and set the overshoot time

Staircase lighting function without pre-warning

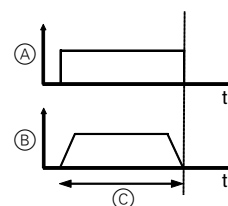

- (A) Switching without pre-warning
- (B) Dimming without pre-warning
- (C) Overshoot time

i In the case of a 2-gang insert, the overshoot time for both channels is set using the potentiometer. In order to double the overshoot time for channel 2, slide DIP switch 2 to "ON".

Staircase lighting function with pre-warning

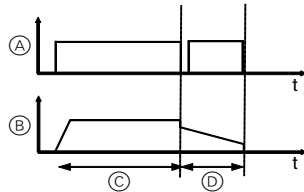
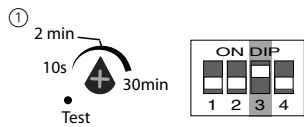

- A Switching with pre-warning
- B Dimming with pre-warning
- C Overshoot time
- D Pre-warning time (30 s, not adjustable)

i In the case of a 2-gang insert, the overshoot time for both channels is set using the potentiometer. In order to double the overshoot time for channel 2, slide DIP switch 2 to "ON".

The pre-warning only applies to channel 1.

Activating/deactivating the presence function

In the case of brightness-dependent movement detection, the sensor module constantly monitors the brightness in the room and compares it to the set brightness threshold. If sufficient natural light is available, the sensor module will switch the lighting off even if a person is present.

The sensor module's presence function is deactivated as a factory default. You can activate the function ("ON") and deactivate it ("OFF") using DIP switch 1.

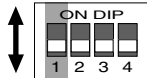

When the presence function has been deactivated, the sensor module continues to carry out the movement detector function.

Setting the 24-h staircase lighting circuit

The DIP switch 4 can be used to set a 24-hour staircase lighting circuit which you can retrieve from another location via PlusLink.

The following options are available for this:

- DIP 4 "ON": only switch on the staircase lighting for 24 h via PL
- DIP 4 "OFF": switch the staircase lighting on/off for 24 h via PL

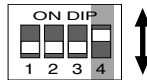

Blocking out areas

If sources of interference (such as light sources) inadvertently switch on the connected luminaires, you can block these areas out. Adjust the sensor module's area of detection by applying, moving or shortening the masking segments supplied:

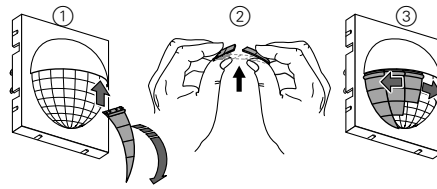

- ① Place the masking segments on the centre of the lens and latch it into place at the top between the hood and the lens.
- ② If necessary: shorten the masking segments at the positions marked so only the close range of the lens is used.
- ③ Move the masking segments precisely onto the area that you wish to block from detection.

i The use of masking segments affects the sensor module's brightness threshold. Readjust the brightness threshold.

Operating the sensor module with switch

(Only for ARGUS 180 flush-mounted sensor module with switch)

You can set three functions using the function switch (A) on the sensor module.

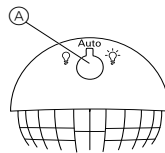

- Position **Auto**: The sensor module is in automatic mode and switches the loads on when movement is detected and then off again after the overshoot time has expired (movement detector function).
- Position (permanently "ON"): load is switched on permanently (no movement detection). Green LED lights up.
- Position (permanently "OFF"): load is switched off permanently (no movement detection). Green LED lights up.

i Notes:

- The function switch has the **highest priority**. All PlusLink commands are ignored at switch positions and .
- In combination with a 2-gang insert the function switch controls both channels together.

Controlling the sensor module from another location

Controlling loads from another location via PlusLink with:

- Push-button module on central unit insert
- Sensor module on central unit insert
- Side controller Plus, 1-gang/2-gang
- Mechanical push-button

Example of global control with push-button module on central unit insert

Starting the staircase lighting function

When the push-button module on the central unit insert (A) is actuated, all local sensor modules (B) in the PL lines start the set staircase lighting function independently of brightness.

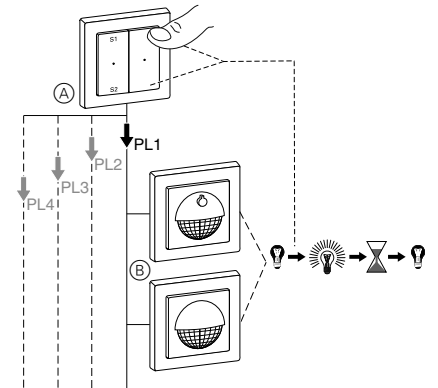

- A Push-button module on central unit insert (alternatively: side controller Plus for one PL line)
- B Sensor module in PL line

24-h staircase lighting circuit

- Upper left push-button: switch on the staircase lighting for 24 h. Green LED lights up.
- Lower left push-button: switch off the staircase lighting for 24 h (prerequisite: DIP 4 on "OFF"). Green LED lights up.

i If DIP 4 is switched to "ON", the lighting cannot be switched off for 24 h.

- Upper/lower right push-button: deactivate the 24-h staircase lighting circuit.

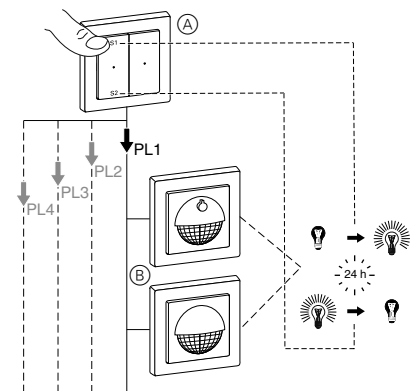

- A Push-button module on central unit insert (alternatively: side controller Plus for one PL line)
- B Sensor module in PL line

Example of global control with mechanical push-button

When the mechanical push-button (A) is actuated, all local sensor modules (B) in the PL lines start the set staircase lighting function independently of brightness.

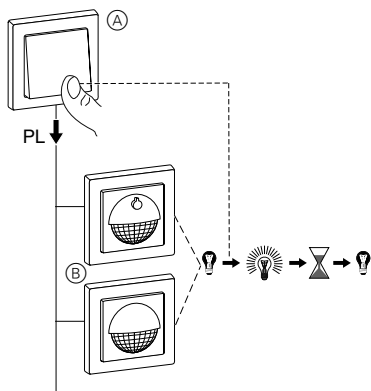

- (A) Mechanical push-button
- (B) Sensor module in PL line

Example of global control with panic button on the central unit insert

When the panic button (B) is actuated, all local sensor modules (C) in the PL lines start a fixed overshoot time lasting 30 minutes (panic scene) independently of brightness. For sensor modules with a switch, the function switch must be set to "Auto" for this.

- i** When a push-button module is used on the central unit insert, the function can be stopped early. Press the right push-button in order to do this.
- When the central unit insert is used in combination with a sensor module, the panic function is not available.

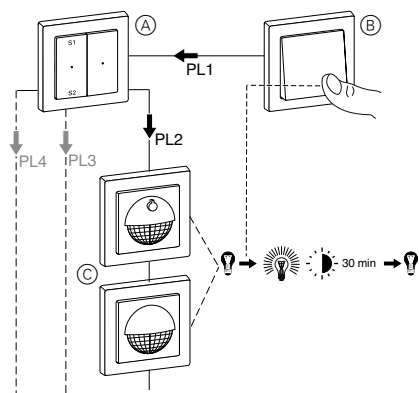

- (A) Push-button module on central unit insert
- (B) Mechanical push-button (panic button)
- (C) Sensor module in PL line

Operating the sensor module: global staircase lighting function via PlusLink

- i** The global control via PlusLink is possible with the combination of a central unit insert and sensor module.

Example of global control via module on the central unit insert

If the sensor module (A) on the central unit insert detects a movement, it sends a trigger command to all local sensor modules (B) in the PL lines.

The local sensor modules (B) check the ambient brightness. The staircase lighting function only starts if the brightness is below the set brightness threshold.

You can also start the staircase lighting function of the push-button modules Comfort and Wiser in the PL lines.

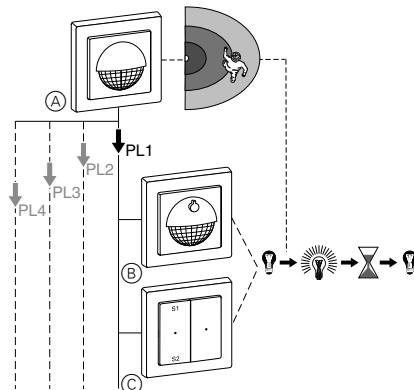

- (A) Sensor module on central unit insert (alternatively: side controller Plus for one PL line)
- (B) Sensor module in PL line 1
- (C) Push-button modules Comfort or Wiser with set staircase lighting function

- i** Notes:
 - Push-button modules (C) without a set staircase lighting function ignore the commands via PlusLink.
 - On the central unit insert, the sensor module always sends independently of brightness.
 - The sensor module function switch does not function on the central unit insert.
 - The sensor module's DIP switches do not function on the central unit insert.

Example of two sensor modules on central unit inserts in the PL line

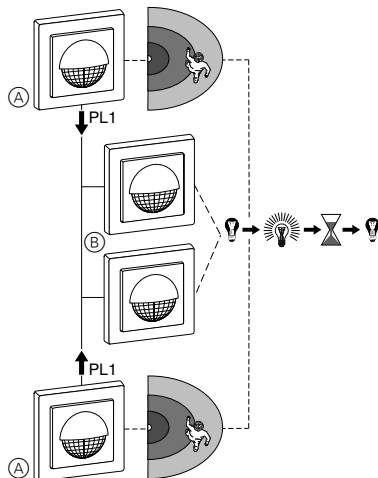

- (A) Sensor module on central unit insert (alternatively: side controller Plus for one PL line)
- (B) Sensor modules in PL line

What should I do if there is a problem?

Load is not switching on.

- The sensitivity is set too low.
 - Reset the sensitivity.
- The brightness threshold is set too low.
 - Reset the brightness threshold.
- For sensor modules with a switch, the function switch is set to .
 - Set the function switch to "Auto".

Load is permanently switched on.

- The overshoot time is set too high. The sensor module constantly detects new movements and restarts the overshoot time.
 - Reduce the overshoot time or sensitivity.
- For sensor modules with a switch, the function switch is set to .
 - Set the function switch to "Auto".

The module is not reacting. The red LED is flashing quickly.

- The sensor module and insert are not compatible (e.g. blind control insert)
 - Plug the sensor module onto a compatible insert (see function overview).

Technical data

Angle of detection:	180°
Number of levels:	6
Number of zones:	46
Number of presence detectors:	2
Recommended mounting height:	1.10 m
Range (adjustable under „Sensitivity“):	max. approx. 8 m to the right/left, approx. 12 m to the front
Brightness threshold:	approx. 10 lux to approx. 1000 lux (infinitely adjustable), brightness independent
Overshoot time:	approx. 10 s to approx. 30 min (infinitely adjustable), test mode (1 s)
Display elements:	1 red LED 1 green LED
Operating elements	
Function switch (only for modules with a switch):	, Auto,
DIP switches:	1: Presence function / movement detector function 2: Double overshoot time for channel 2 3: Prewarning for channel 1 4: 24-h staircase lighting circuit module interface with 8 contact pins
Connection:	



Dispose of the device separately from household waste at an official collection point. Professional recycling protects people and the environment against potential negative effects.

Schneider Electric Industries SAS

If you have technical questions, please contact the Customer Care Centre in your country.
schneider-electric.com/contact